

Ø Features/特征:

- I Single color/单色
- I High bright output/高亮度输出
- I Low power consumption/低功耗
- I High reliability and long life/
可靠性高、寿命长

Ø Descriptions/描述:

- I Dice material/芯片材质: InGaN
- I Emitting Color/发光颜色:
Super Bright Green/ 高亮度绿色
- I Device Outline/产品外形:
φ5mm Round Type/ 5mm 圆形
- I Lens Type 胶体颜色:
Water Clear/ 无色透明

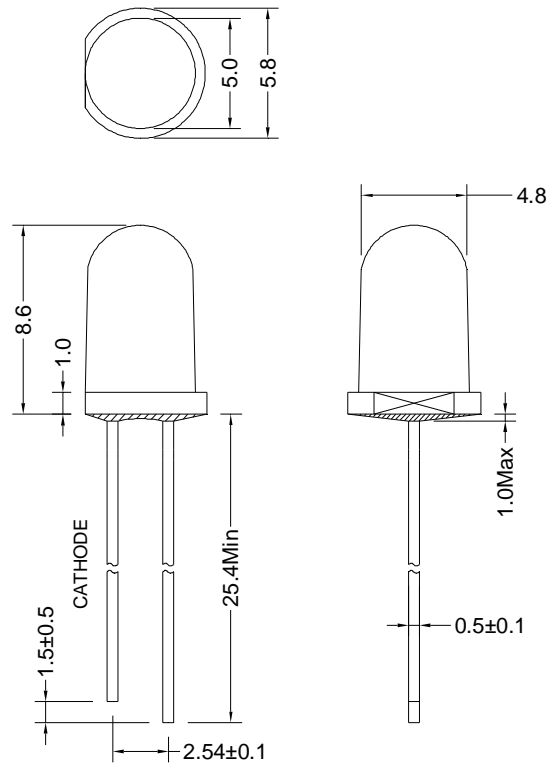

1. All dimensions are millimeters/单位: mm.
2. Tolerance is +/-0.20mm unless otherwise noted/
没有标注的公差均为±0.20mm.

Ø Directivity/指向特性:

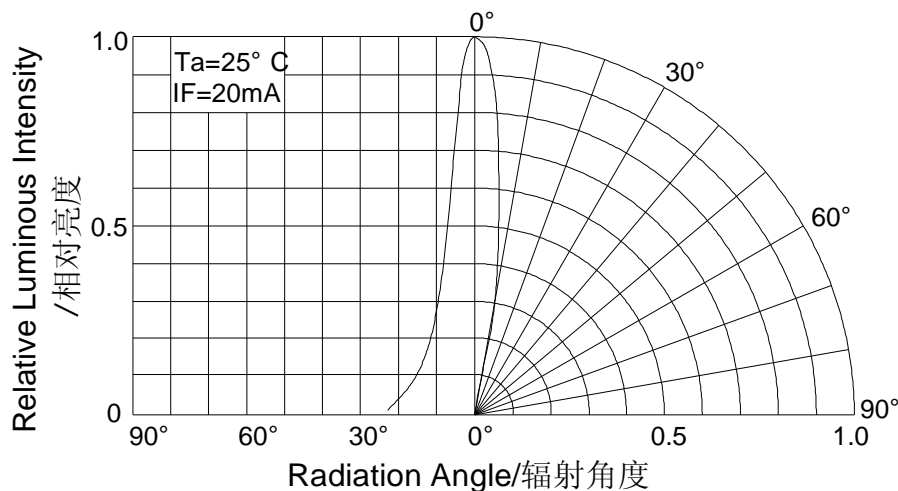

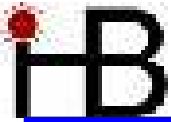

Ø Absolute maximum ratings/极限参数 (Ta = 25°C)

| Parameter 参数 | Symbol 符号 | Test Condition 测试条件 | Values 数值 | | Unit 单位 |
|---------------------------------|-------------------|-------------------------|-----------|------|------------|
| | | | Min. | Max. | |
| Reverse Voltage 反向电压 | V _R | I _R = 30 μ A | 5 | -- | V |
| Forward Current 正向工作电流 | I _F | ---- | ---- | 25 | mA |
| Power Dissipation 损耗功率 | P _d | ---- | ---- | 90 | mW |
| Pulse Current 正向峰值电流 | I _{peak} | Duty=0.1mS, 1kHz | ---- | 100 | mA |
| Operating Temperature 工作温度范围 | T _{opr} | ---- | -40 | +85 | °C |
| Storage Temperature 储存温度范围 | T _{str} | ---- | -40 | +100 | °C |

Ø Electrical and optical characteristics/光电参数 (Ta = 25°C)

| Parameter 参数 | Symbol 符号 | Test Condition 测试条件 | Values 数值 | | | Unit 单位 |
|-----------------------------------|----------------|------------------------|-----------|-------|------|------------|
| | | | Min. | Typ. | Max. | |
| Forward Voltage 正向电压 | V _F | I _F =20mA | ---- | 3.2 | 3.6 | V |
| Reverse Current 反向电流 | I _R | V _R =5V | ---- | ---- | 30 | μ A |
| Dominate Wavelength 主波长 | λ _d | I _F =20mA | ---- | 525 | ---- | nm |
| Peak Wavelength 峰值波长 | λ _p | I _F =20mA | ---- | 520 | ---- | nm |
| Spectral Line half-width 半波长宽度 | Δ λ | I _F =20mA | ---- | 20 | ---- | nm |
| Luminous Intensity 发光强度 | I _v | I _F =20mA | 6000 | 10000 | ---- | mcd |
| Viewing Angle 指向角度 | 2 θ 1/2 | I _F =20mA | ---- | 15 | ---- | deg. |

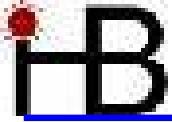

Ø Typical electrical/optical characteristic curves/光电特性曲线:

Fig.1 正向电流 Vs. 正向电压

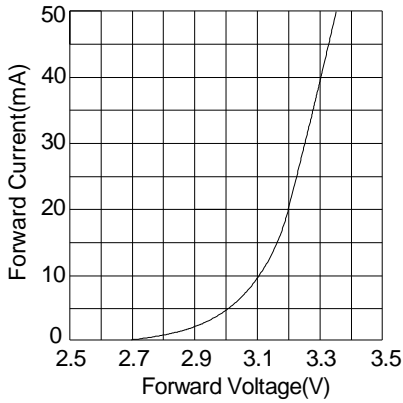

Fig.2 相对亮度 Vs. 正向电流

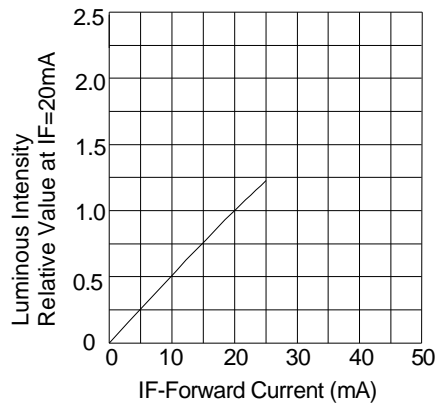

Fig.3 正向电流 Vs. 环境温度

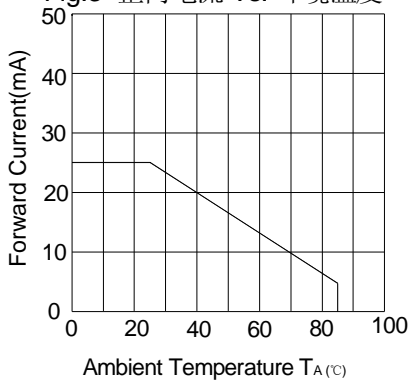

Fig.4 相对亮度 Vs. 环境温度

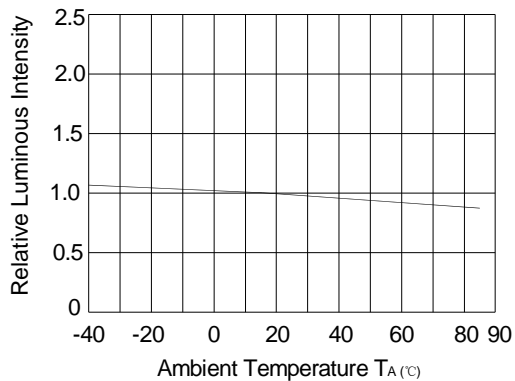

Fig.5 相对亮度 Vs. 波长

