

Part No.: **774PG2T-S**



ATTENTION
OBSERVE PRECAUTIONS
FOR HANDLING
ELECTROSTATIC
DISCHARGE
SENSITIVE
DEVICES

➤ **Features/特征:**

- Single color/单色
- High bright output/高亮度输出
- Low power consumption/低功耗
- High reliability and long life/
可靠性高、寿命长

➤ **Descriptions/描述:**

- Dice material/芯片材质: InGaN
- Emitting Color/发光颜色:
Super Bright Green/ 高亮度绿色
- Device Outline/产品外形:
5.2×4.6mm Oval Type / 5.2×4.6mm 椭圆形
- Lens Type 胶体颜色:
Green Diffused / 绿色散射

➤ **Directivity/指向特性:**

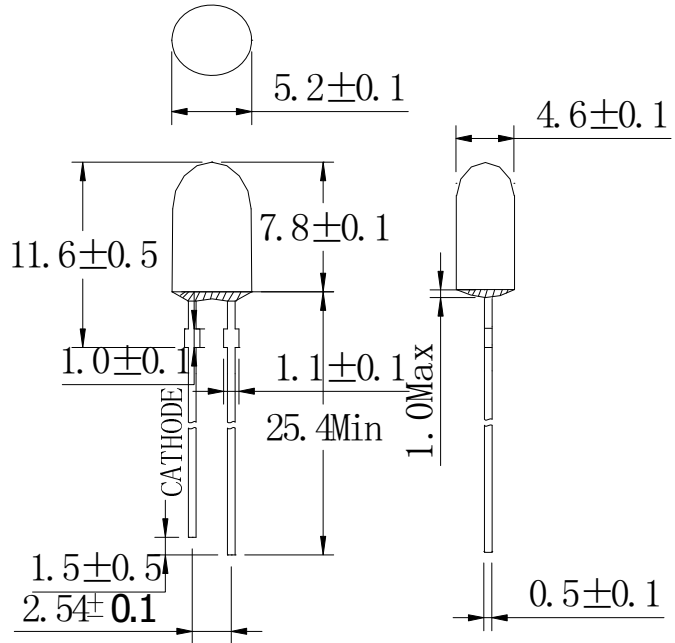

NOTE/备注:

1. All dimensions are millimeters/单位: mm.
2. Tolerance is +/-0.25mm unless otherwise noted/
没有标注的公差均为±0.25mm.

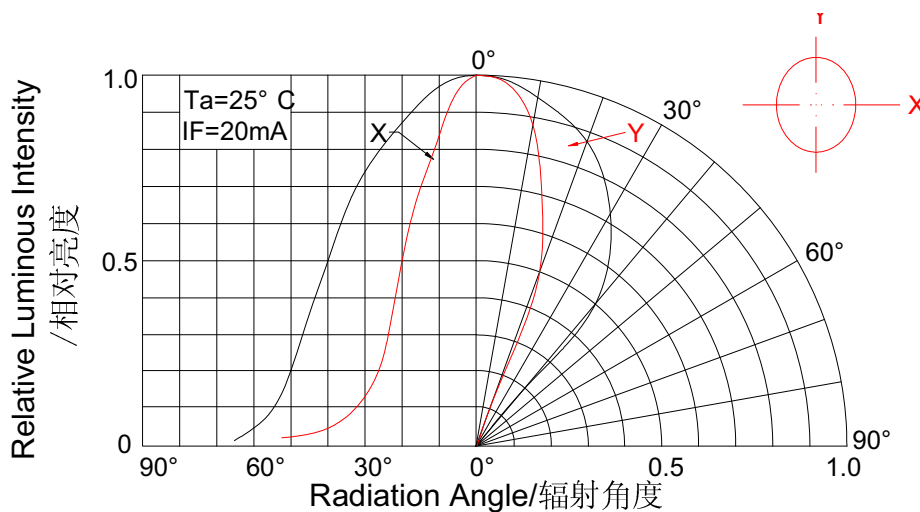

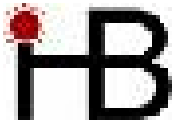
Part No.: 774PG2T-S

➤ Absolute maximum ratings/极限参数 (Ta = 25°C)

Parameter 参数	Symbol 符号	Test Condition 测试条件	Values 数值		Unit 单位
			Min.	Max.	
Reverse Voltage 反向电压	V _R	I _R = 30 μA	5	--	V
Forward Current 正向工作电流	I _F	----	----	25	mA
Power Dissipation 损耗功率	P _d	----	----	100	mW
Pulse Current 正向峰值电流	I _{peak}	Duty=0.1mS, 1kHz	----	100	mA
Operating Temperature 工作温度范围	T _{opr}	----	-40	+85	°C
Storage Temperature 储存温度范围	T _{str}	----	-40	+100	°C

➤ Electrical and optical characteristics/光电参数 (Ta = 25°C)

Parameter 参数	Symbol 符号	Test Condition 测试条件	Values 数值			Unit 单位
			Min.	Typ.	Max.	
Forward Voltage 正向电压	V _F	I _F =20mA	----	3.2	3.6	V
Reverse Current 反向电流	I _R	V _R =5V	----	----	30	μA
Dominate Wavelength 主波长	λ _d	I _F =20mA	----	525	----	nm
Peak Wavelength 峰值波长	λ _p	I _F =20mA	----	520	----	nm
Spectral Line half-width 半波长宽度	Δλ	I _F =20mA	----	35	----	nm
Luminous Intensity 发光强度	I _v	I _F =20mA	----	1500	2100	mcd
Viewing Angle 指向角度	2θ _{1/2}	I _F =20mA	----	70/40	----	deg.

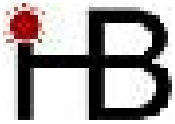

➤ Typical electrical/optical characteristic curves/光电特性曲线:

Fig.1 正向电流 Vs. 正向电压

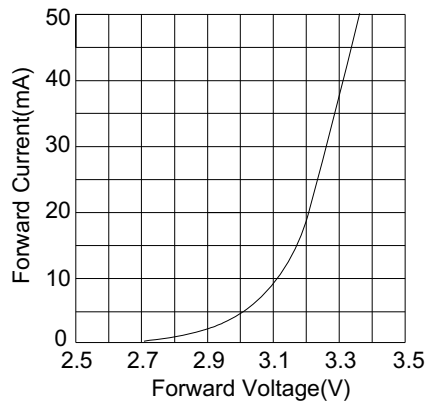

Fig.2 相对亮度 Vs. 正向电流

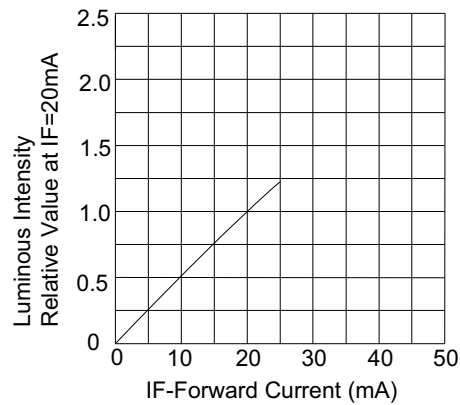

Fig.3 正向电流 Vs. 环境温度

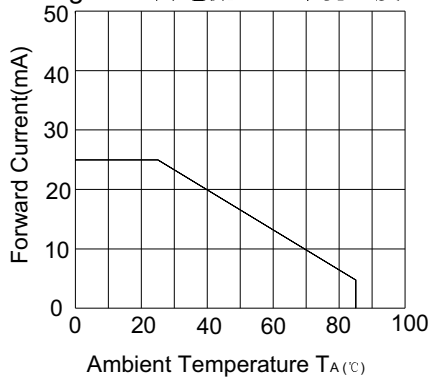

Fig.4 相对亮度 Vs. 环境温度

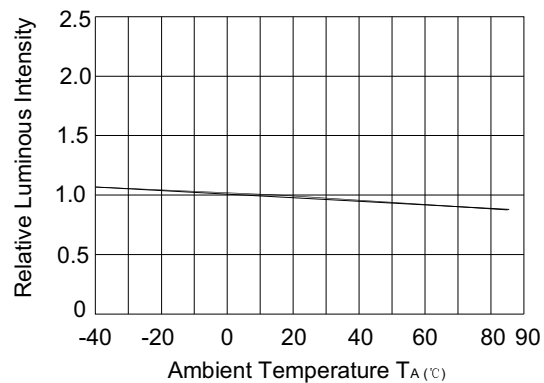

Fig.5 相对亮度 Vs. 波长

