



FLUX LED SPECIFICATION



ATTENTION
OBSERVE PRECAUTIONS
FOR HANDLING
ELECTROSTATIC
DISCHARGE
SENSITIVE
DEVICES

980MY8C

Features:

- Single color
- High bright output
- High Current Operation
- Low power consumption
- High reliability and long life

Descriptions:

- Dice material: AlGaInP
- Emitting Color: Amber (Yellow)
- Device Outline: 7.6mmX7.6mm
- Lens Type: Water Clear

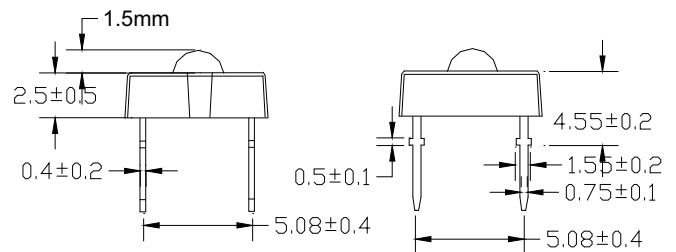
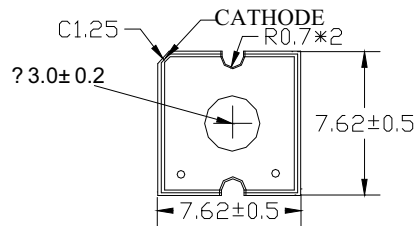

NOTE:

- All dimensions are millimetres.
- Tolerance is +/-0.25mm unless otherwise

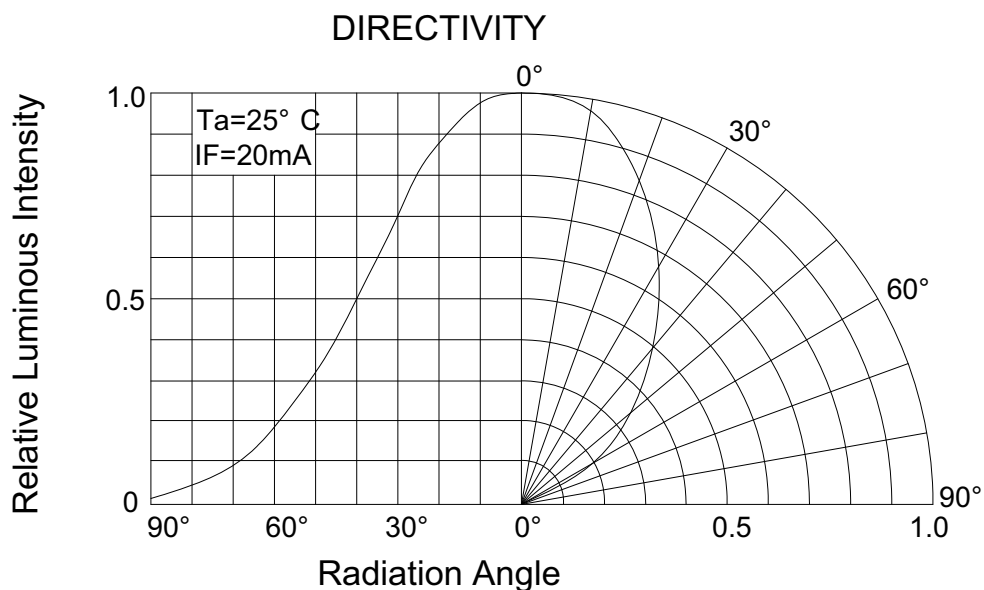



LED SPECIFICATION

Absolute maximum ratings (Ta = 25°C)

Parameter	Symbol	Test Condition	Value		Unit
			Min.	Max.	
Reverse Voltage	V _R	I _R = 30 μ A	5	--	V
Forward Current	I _F	----	----	50	mA
Power Dissipation	P _d	----	----	75	mW
Pulse Current	I _{peak}	Duty=0.1mS, 1kHz	----	100	mA
Operating Temperature	T _{opr}	----	-40	+85	°C
Storage Temperature	T _{str}	----	-40	+100	°C

Electrical and optical characteristics (Ta = 25°C)

Parameter	Symbol	Test Condition	Value			Unit
			Min.	Typ.	Max.	
Forward Voltage	V _F	I _F = 50mA		V3~V5		
Reverse Current	I _R	V _R = 5V	----	----	30	μ A
Dominate Wavelength	λ _d	I _F = 50mA		Y2~Y4		
Spectral Line half-width	Δ λ	I _F = 50mA		20		nm
Luminous Flux	I _V	I _F = 50mA		G,H,J		
Viewing Angle	2 θ 1/2	I _F = 50mA	70		80	Deg.

FLUX BIN FOR PIRANHA (UFO) LEDS

Bin Code	LM	Bin Code	LM	Bin Code	LM	Bin Code	LM
A	<=0.46	E	1.0-1.3	J	2.8-3.6	N	7.8-10.0
B	0.46-0.60	F	1.3-1.7	K	3.6-4.7	P	10-13
C	0.60-0.77	G	1.7-2.2	L	4.7-6.0	Q	13-17
D	0.77-1.0	H	2.2-2.8	M	6.0-7.8	R	17-22

WAVELENGTH BIN

Ligth Col.	Bin Code	Wavel. (nm)	Ligth Col.	Bin Code	Wavel. (nm)
BLUE	B1	450-455	YELLOW GREEN	YG1	555-558
	B2	455-460		YG2	558-561
	B3	460-465		YG3	561-564
	B4	465-470		YG4	564-567
	B5	470-475		YG5	567-570
	B6	475-480		YG6	570-573
BLUE GREEN	G1	491-494		YG7	573-576
	G2	494-497	YELLOW	Y1	582-585
	G3	497-500		Y2	585-588
	G4	500-503		Y3	588-591
	G5	503-506		Y4	591-594
	G6	506-509		Y5	594-597
	G7	509-512	YELLOW ORANGE	YO1	597-600
	G8	512-515		YO2	600-603
G9	515-518	YO3		603-606	
PURE GREEN	G10	518-521	YO4	606-609	
	G11	521-524	PURE ORANGE	O1	609-612
	G12	524-527		O2	612-615
	G13	527-530		O3	615-618
	G14	530-533	RED	R1	618-621
	G15	533-536		R2	621-624
	G16	536-539		R3	624-627
	G17	539-542		R4	627-630
	G18	542-545		R5	630-633
	G19	545-548		R6	633-636

FORWARD VOLTAGE (VF) BIN

Bin Code	VF (V)	Bin Code	VF (V)	Bin Code	VF (V)	Bin Code	VF (V)
V1	1.6-1.8	V5	2.4-2.6	V9	3.2-3.4	V13	4.0-4.2
V2	1.8-2.0	V6	2.6-2.8	V10	3.4-3.6	V14	4.2-4.4
V3	2.0-2.2	V7	2.8-3.0	V11	3.6-3.8	V15	4.4-4.6
V4	2.2-2.4	V8	3.0-3.2	V12	3.8-4.0	V16	4.6-4.8



FLUX LED SPECIFICATION

Typical electrical/optical characteristic curves:

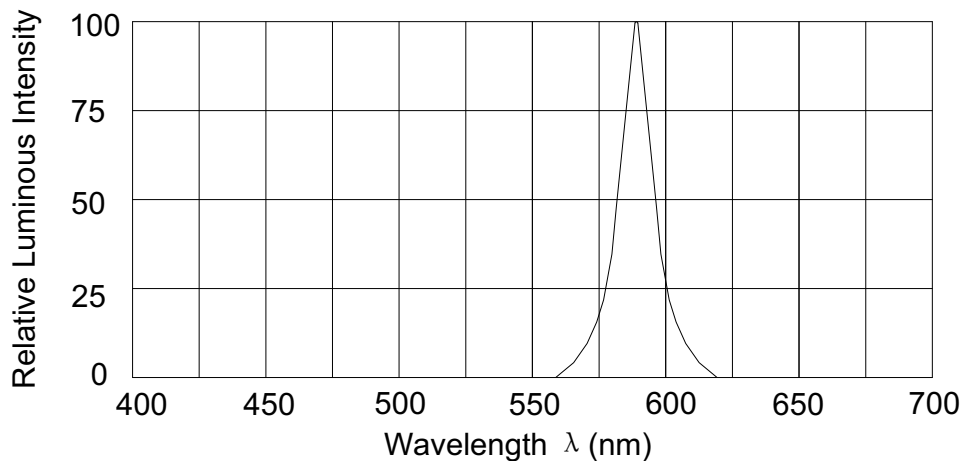
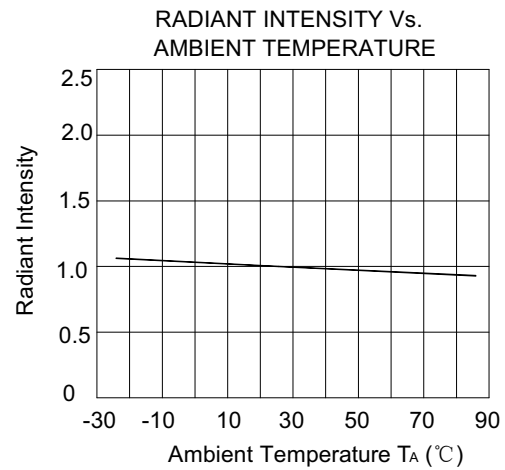
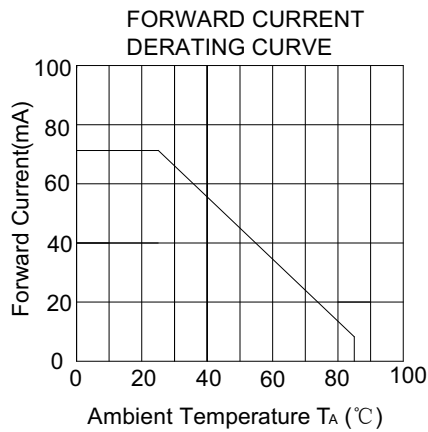
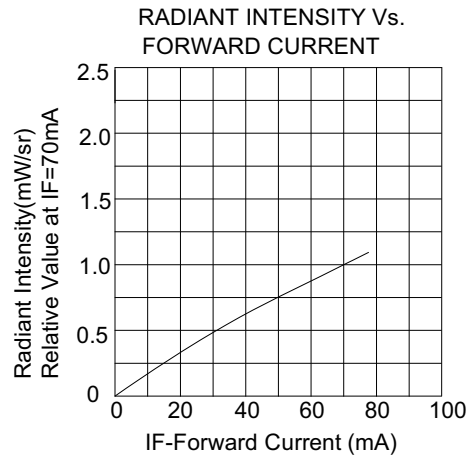
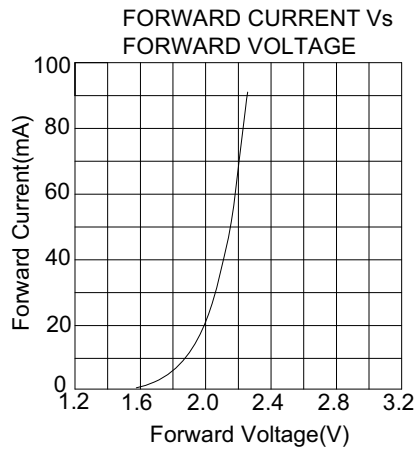



LED LAMP APPLICATION

•SOLDERING

METHOD	SOLDERING CONDITIONS	REMARK
DIP SOLDERING	Bath temperature: $260 \pm 5^\circ\text{C}$ Immersion time: with 5 sec	<ul style="list-style-type: none"> Solder no closer than 3mm from the base of the package Using soldering flux, "RESIN FLUX" is recommended.
SOLDERING IRON	Soldering iron: 30W or smaller Temperature at tip of iron: 260°C or lower Soldering time: within 5 sec.	<ul style="list-style-type: none"> During soldering, take care not to press the tip of iron against the lead. (To prevent heat from being transferred directly to the lead, hold the lead with a pair of tweezers while soldering)

1) When soldering the lead of LED in a condition that the package is fixed with a panel (See Fig.1), be careful not to stress the leads with iron tip.

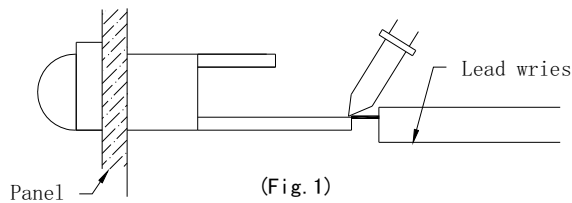

2) When soldering wire to the lead, work with a Fig (See Fig.2) to avoid stressing the package.

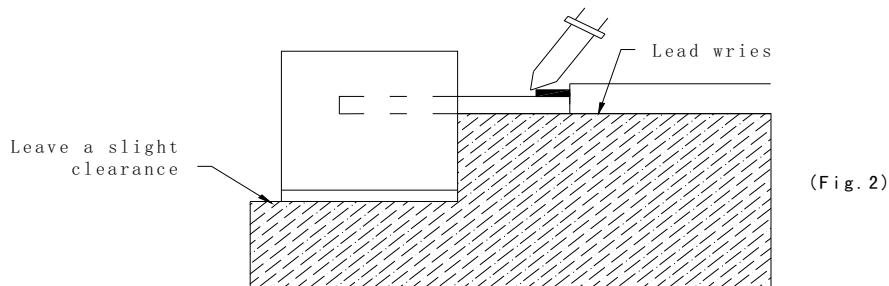

- 3) Similarly, when a jig is used to solder the LED to PC board, take care as much as possible to avoid steering the leads (See Fig.3).

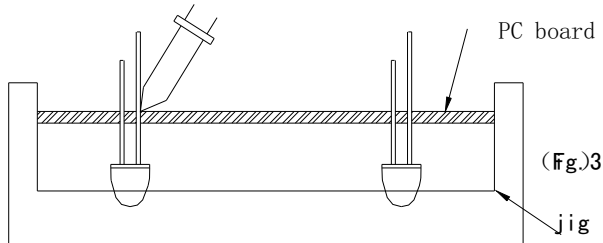

- 4) Repositioning after soldering should be avoided as much as possible. If inevitable, be sure to preserve the soldering conditions with irons stated above: select a best-suited method that assures the least stress to the LED.
- 5) Lead cutting after soldering should be performed only after the LED temperature has returned to normal temperature.

•LED MOUNTING METHOD

- 1) When mounting the LED by using a case, as shown Fig.4, ensure that the mounting holds on the PC board match the pitch of the leads correctly-tolerance of dimensions of the respective components including the LED should be taken into account especially when designing the case, PC board, etc. to prevent pitch misalignment between the leads and board holes, the diameter of the board holes should be slightly larger than the size of the lead. Alternatively, the shape of the holes should be made oval. (See Fig.4)

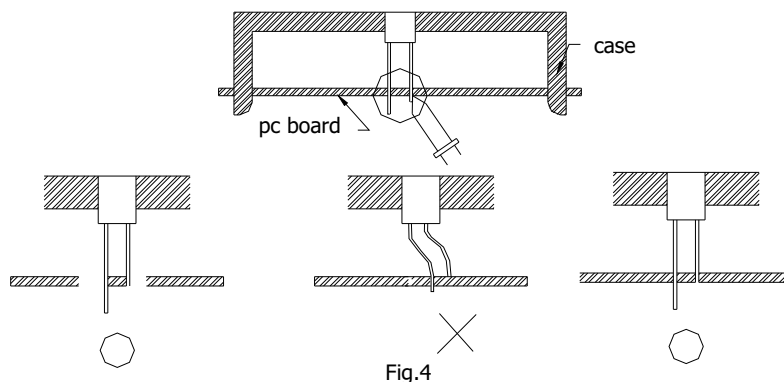

2) Use LEDs with stand-off (Fig.5) or the tube or spacer made of resin (Fig.6) to position the LEDs.

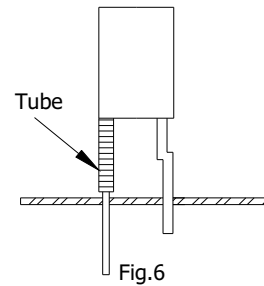
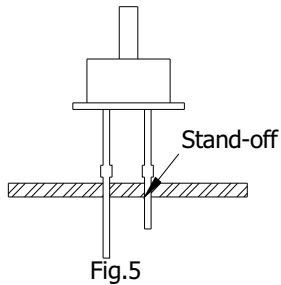

•FORMED LEAD

1) The lead should be bent at a point located at least 2mm away from the package. Bending should be performed with base fixed means of a jig or pliers (Fig.7)

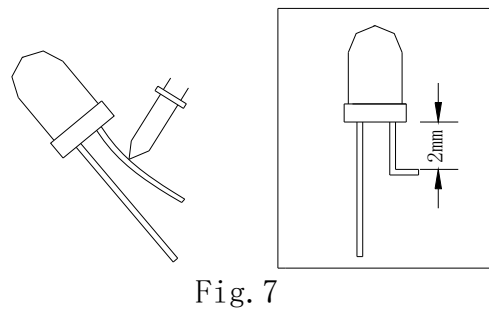

2) Forming lead should be carried out prior to soldering and never during or after soldering.
 3) Form the lead to ensure alignment between the leads and the hole on board, so that stress against the LED is prevented. (Fig.8)

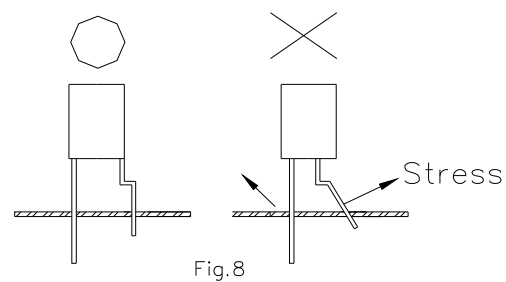



•LEAD STRENGTH

1) Bend strength

Do not bend the lead more than twice. (Fig.9)

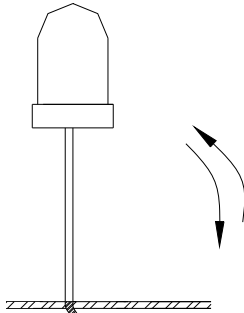

Fig.9

2) Tensile strength (@Room Temperature)

If the force is 1kg or less, there will be no problem. (Fig.10)

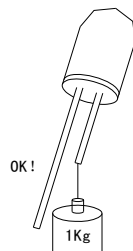

Fig.10

•HANDLING PRECAUTIONS

Although rigid against vibration, the LEDs may damaged or scratched if dropped. So take care when handling.

•CHEMICAL RESISTANCE

- 1) Avoid exposure to chemicals as it may attack the LED surface and cause discoloration.
- 2) When washing is required, refer to the following table for the proper chemical to be sued.

(Immersion time: within 3 minutes at room temperature.)

SOLVENT	ADAPTABILITY
Freon TE	⊙
Chlorothene	×
Isopropyl Alcohol	⊙
Thinner	×
Acetone	×
Trichloroethylene	×

⊙--Usable ×--Do not use.

NOTE: Influences of ultrasonic cleaning of the LED resin body differ depending on such factors as the oscillator output, size of the PC board and the way in which the LED is mounted. Therefore, ultrasonic cleaning should only be performed after confirming there is no problem by conducting a test under practical.



LED LAMP PASSED TESTS

Experiment Item:

Item	Test Condition	Reference Standard
	Lamp & IR	
OPERATION LIFE	$T_a : 25 \pm 5^\circ\text{C}$ $I_F = 20\text{mA}$ RH : $\leq 60\%RH$ ① DYNAMIC: 100mA 1ms $1/10$ duty ② STATIC STATE: $I_F = 20\text{mA}$ TEST TIME: 168HRS (-24HRS , $+24\text{HRS}$) 500HRS (-24HRS , $+24\text{HRS}$) 1000HRS (-24HRS , $+72\text{HRS}$)	MIL-STD-750 : 1026 MIL-STD-883 : 1005 JIS C 7021 : B-1
HIGH TEMPERATURE HIGH HUMIDITY STORAGE	$T_a : 65^\circ\text{C} \pm 5^\circ\text{C}$ RH : $90 \sim 95\%RH$ TEST TIME : $240\text{HRS} \pm 2\text{HRS}$	MIL-STD-202 : 103B JIS C 7021 : B-1
TEMPERATURE CYCLING	$105^\circ\text{C} \sim 25^\circ\text{C} \sim -55^\circ\text{C} \sim 25^\circ\text{C}$ 30min 5min 30min 5min 10CYCLES	MIL-STD-202 : 107D MIL-STD-750 : 1051 MIL-STD-883 : 1010 JIS C 7021 : A-4
THERMAL SHOCK	$105^\circ\text{C} \pm 5^\circ\text{C} \sim -55^\circ\text{C} \pm 5^\circ\text{C}$ 10min 10min 10CYCLES	MIL-STD-202 : 107D MIL-STD-750 : 1051 MIL-SYD-883 : 1011
SOLDER RESISTANCE	$T, \text{sol} : 260^\circ\text{C} \pm 5^\circ\text{C}$ DWELL TIME : $10 \pm 1\text{sec}$	MIL-STD-202 : 210A MIL-STD-750-2031 JIS C 7021 : A-1
SOLDERABILITY	$T, \text{sol} : 230^\circ\text{C} \pm 5^\circ\text{C}$ DWELL TIME : $5 \pm 1\text{sec}$	MIL-STD-202 : 208D MIL-STD-750 : 2026 MIL-STD-883 : 2003 JIS C 7021 : A-2

Drive Method

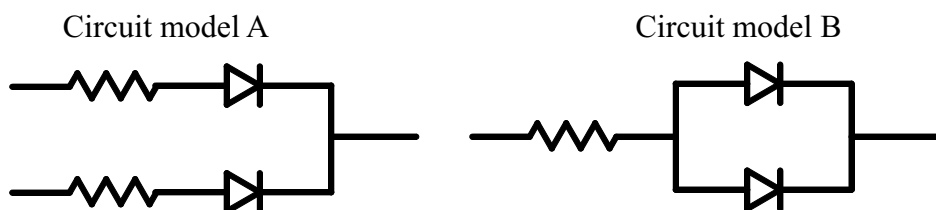

(A) Recommended circuit.

(B) The difference of brightness between LED's could be found due to the V_f - I_f characteristics of LED.