

ATTENTION

OBSERVE PRECAUTIONS
FOR HANDLING
ELECTROSTATIC
DISCHARGE
SENSITIVE
DEVICES

Part No.: **PLCC2LW3CT**

1、Features/特征:

- Emitting Color/发光颜色: White/白色
- Lens Type/封装特性: Yellow Diffused/黄色散射
- Device Outline/外形特征: 3.5×2.8×1.9 (unit:mm)
- HBM ESD:Class 2/人体抗静电指标: Class 2
- Pb-Free/无铅
- RoHS compliant/符合 RoHS 标准

2、Applications/应用:

- Backlight for Mobile, Machine Vision, LCD Display/手机、电话、显示屏背光源
- Backlight in Dashboard and switch of Automive/汽车仪表盘、记程器背光源

3、Outline Dimensions/产品外形尺寸:

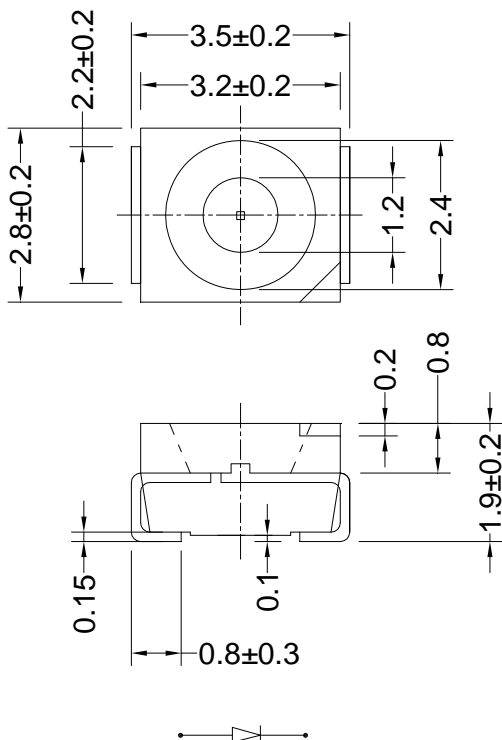

被推荐的焊盘尺寸

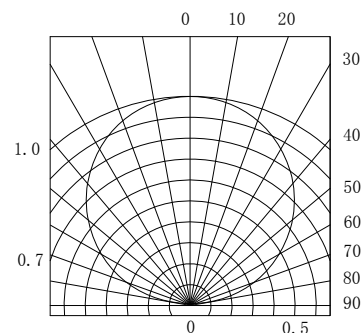
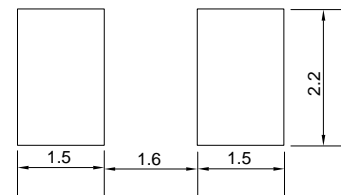

SPATIAL DISTRIBUTION



4、Absolute maximum ratings/极限参数 (Ta = 25℃):

Parameter 参数	Symbol 符号	Test Condition 测试条件	Value 参数		Unit 单位
			Min.	Max.	
Power Dissipation 损耗功率	Pd	—	—	90	mW
Reverse Voltage 反向电压	VR	IR = 30 μ A	5	—	V
Pulse Current 正向峰值电流	IFp	Duty=0.1, 1kHz	—	100	mA
Forward Current 正向工作电流	IFm	—	—	25	mA
Operating Temperature 工作温度范围	Topr	—	-40	+85	℃
Storage Temperature 储存温度范围	Tstr	—	-40	+85	℃

5、Electrical and optical characteristics/光电参数 (Ta = 25℃):

Parameter 参数	Symbol 符号	Test Condition 测试条件	Value 参数			Unit 单位
			Min.	Typ.	Max.	
Forward Voltage 正向电压	VF	IF = 20mA	—	3.2	3.6	V
Reverse Current 反向电流	IR	VR = 5V	—	—	30	μ A
Chromaticity coordinates 色坐标	CIE-X	IF = 20mA	—	—	—	-----
	CIE-Y		—	—	—	
Luminous Intensity 发光强度	Iv	IF = 20mA	-----	1200	—	mcd
Viewing Angle 发光指向角	2 θ 1/2	IF = 20mA	—	120	—	Deg.

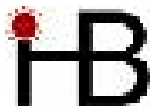

6、Chromaticity coordinates Ranks /色坐标分档:

色坐标误差: ± 0.01

代码	轴	参数				代码	轴	参数			
We1	X	0.387	0.379	0.392	0.400	We2	X	0.400	0.409	0.395	0.387
	Y	0.380	0.392	0.407	0.396		Y	0.396	0.384	0.368	0.380
We3	X	0.403	0.395	0.409	0.417	We4	X	0.400	0.392	0.405	0.414
	Y	0.356	0.368	0.384	0.372		Y	0.396	0.407	0.423	0.411
We5	X	0.414	0.422	0.409	0.400	We6	X	0.417	0.409	0.422	0.430
	Y	0.411	0.399	0.384	0.396		Y	0.372	0.384	0.399	0.388
We7	X	0.414	0.405	0.419	0.427	We8	X	0.427	0.435	0.422	0.414
	Y	0.411	0.423	0.438	0.426		Y	0.426	0.415	0.399	0.411
We9	X	0.430	0.422	0.435	0.443	We10	X	0.427	0.419	0.432	0.440
	Y	0.388	0.399	0.415	0.403		Y	0.426	0.438	0.454	0.442
We11	X	0.440	0.448	0.435	0.427	We12	X	0.443	0.435	0.448	0.457
	Y	0.442	0.430	0.415	0.426		Y	0.403	0.415	0.430	0.418
We13	X	0.440	0.432	0.445	0.453	We14	X	0.453	0.461	0.448	0.440
	Y	0.442	0.454	0.469	0.457		Y	0.457	0.445	0.430	0.442
We15	X	0.457	0.448	0.461	0.469	Wg1	X	0.379	0.371	0.384	0.392
	Y	0.418	0.430	0.445	0.433		Y	0.392	0.404	0.419	0.407
Wg2	X	0.392	0.384	0.397	0.405	Wg3	X	0.405	0.397	0.410	0.419
	Y	0.407	0.419	0.435	0.423		Y	0.423	0.435	0.450	0.438
Wg4	X	0.419	0.410	0.424	0.432	Wg5	X	0.432	0.424	0.437	0.445
	Y	0.438	0.450	0.465	0.454		Y	0.454	0.465	0.481	0.469

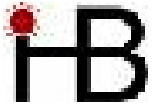

Diagram

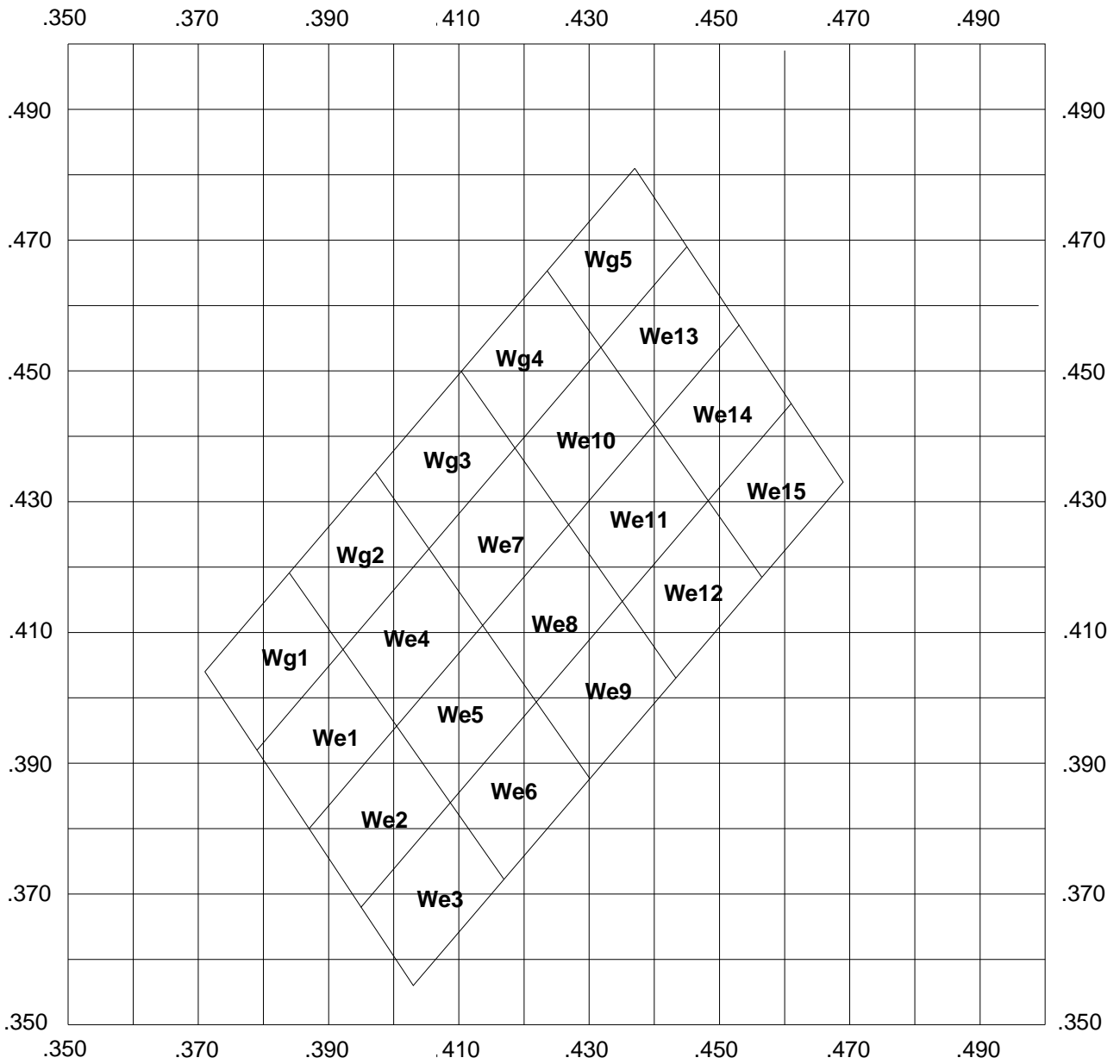

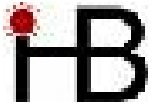

7、Typical electrical/optical characteristic curves/光电特性曲线:

Fig.1 正向电流 Vs. 正向电压

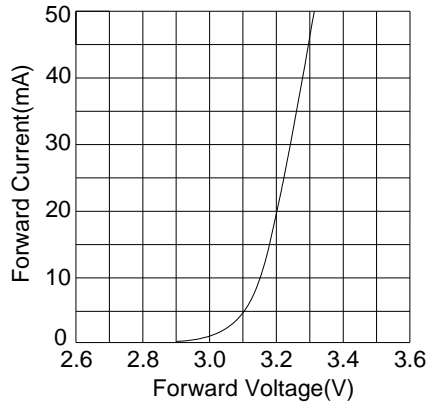

Fig.2 相对亮度 Vs. 正向电流

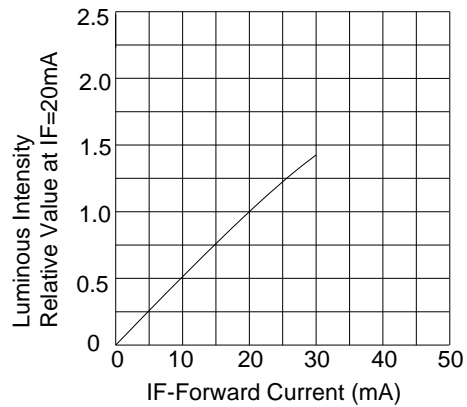

Fig.3 正向电流 Vs. 环境温度

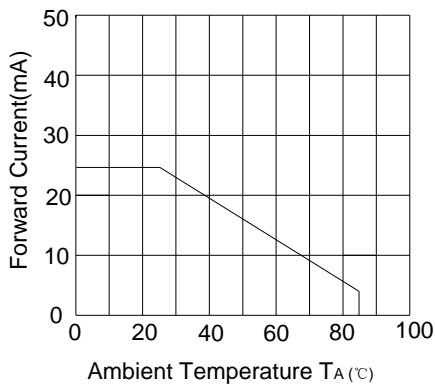

Fig.4 相对亮度 Vs. 环境温度

