

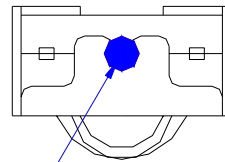

● Package Dimensions

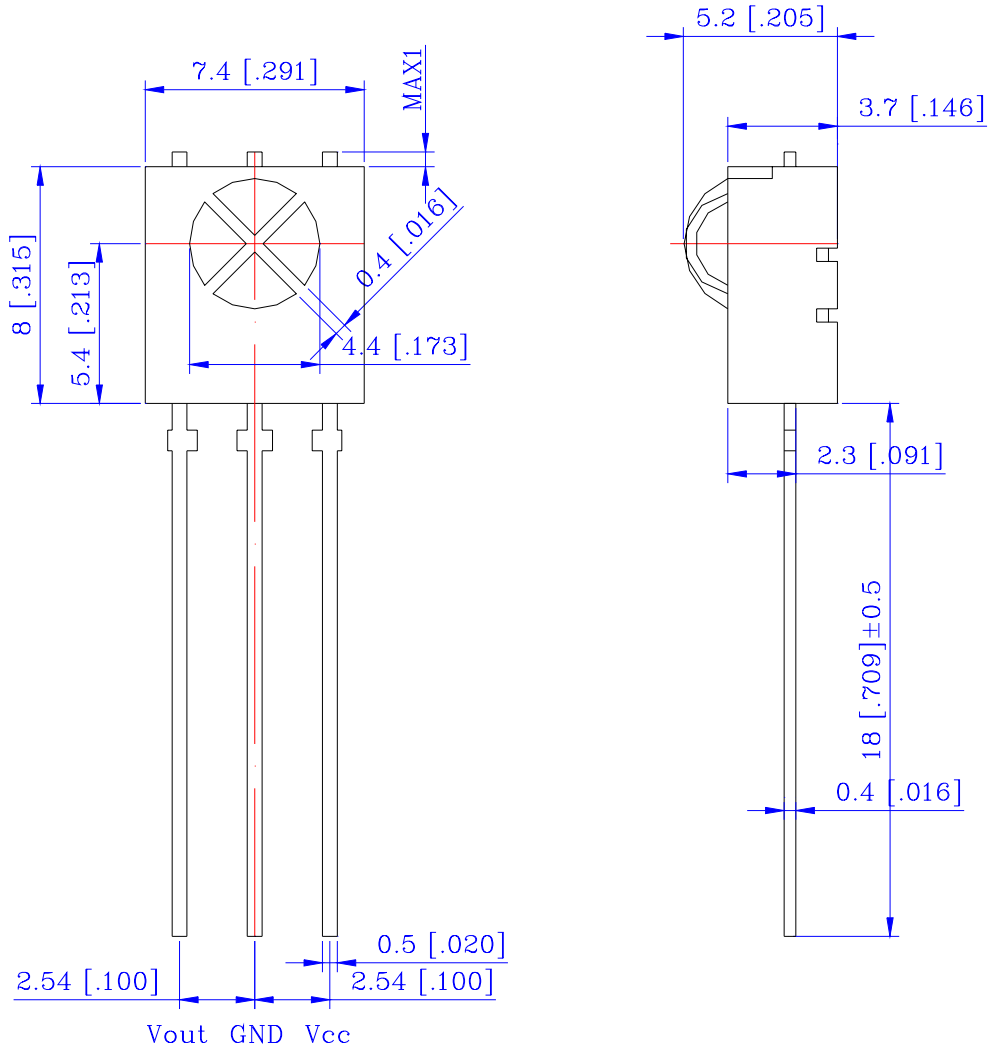

HATCH GND(GND SOLDER)

NOTES :

1. All dimensions are in millimeters.
2. Tolerance is $\pm 0.25(0.010)$ unless otherwise specified



● Description

- ✧ A miniaturized receiver for infrared remote control and IR data transmission.
- ✧ PIN diode and preamplifier are assembled on lead frame.
- ✧ The epoxy package is designed as IR filter.
- ✧ The demodulated output signal can directly be decoded by a microprocessor. The main benefit is the operation with high data rates and long distances.

● Features

- ✧ Photo detector and preamplifier in one package
- ✧ Internal band filter for PCM frequency
- ✧ Internal shielding against electrical field disturbance
- ✧ TTL and CMOS compatibility
- ✧ Output active low
- ✧ Small size package

● Special Features

- ✧ Supply voltage 5.5 V
- ✧ Short settling time after power on
- ✧ High envelope duty cycle can be received
- ✧ Enhanced immunity against disturbance from energy saving lamps

● Application

- ✧ AV instruments such as Audio, TV, VCR, CD, DVD, MD etc.
- ✧ Home appliances such as Air conditioner, Fan etc.
- ✧ The other equipments with wireless remote control.
- ✧ CATV set top boxes.
- ✧ Multi-media Equipment.
- ✧ Sensors and light barrier systems for long distances



● Block Diagram

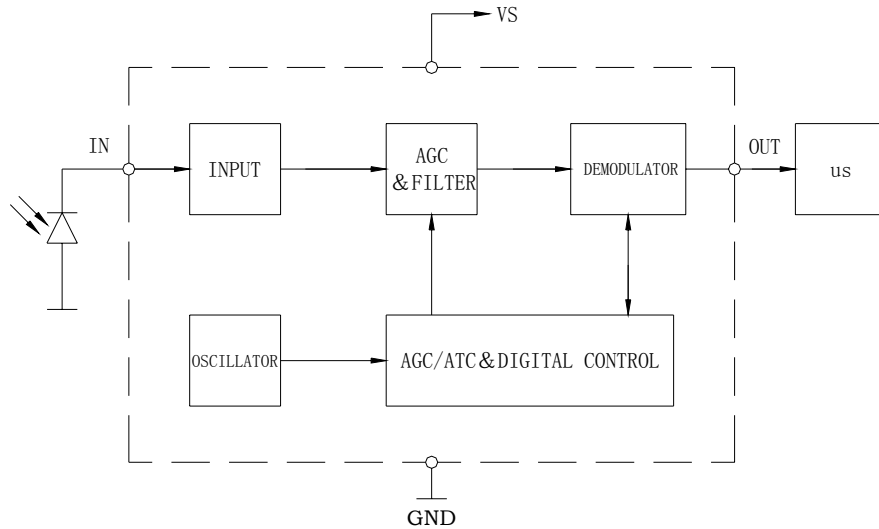

● Application Circuit

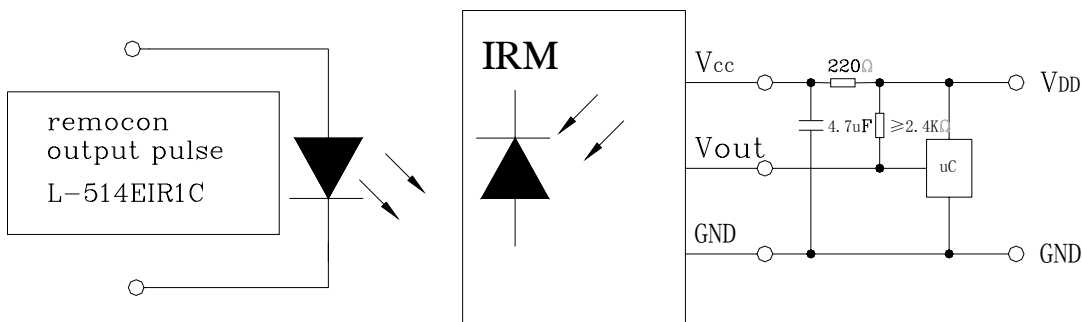

● Transmit Signal (Carrier Frequency= f_0)

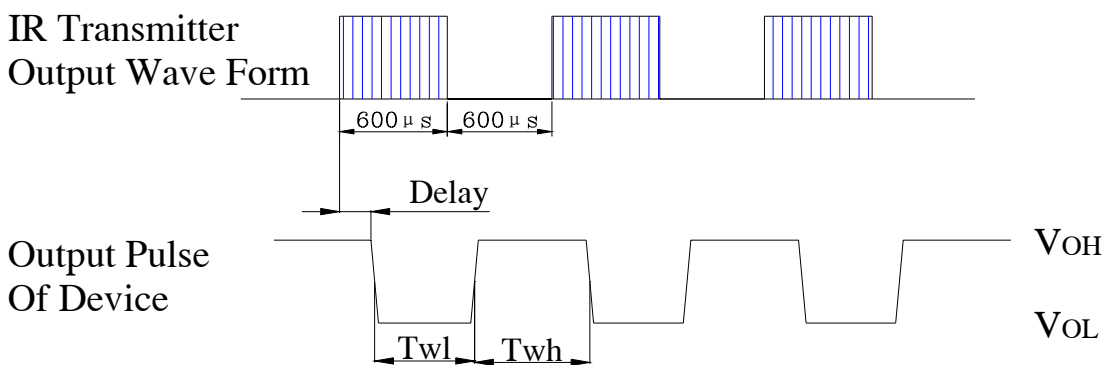



● Data Transmission Rate, $V_s=5V$

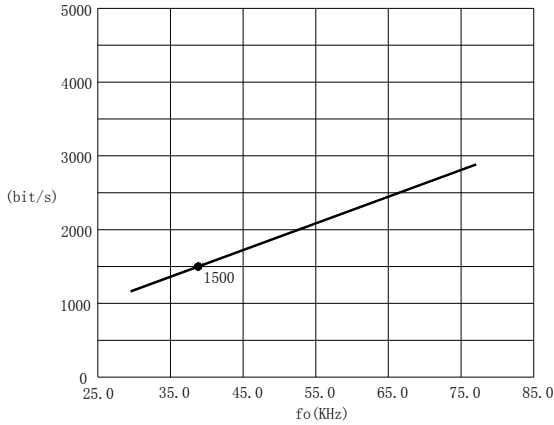

● Illustration Of Used Terms

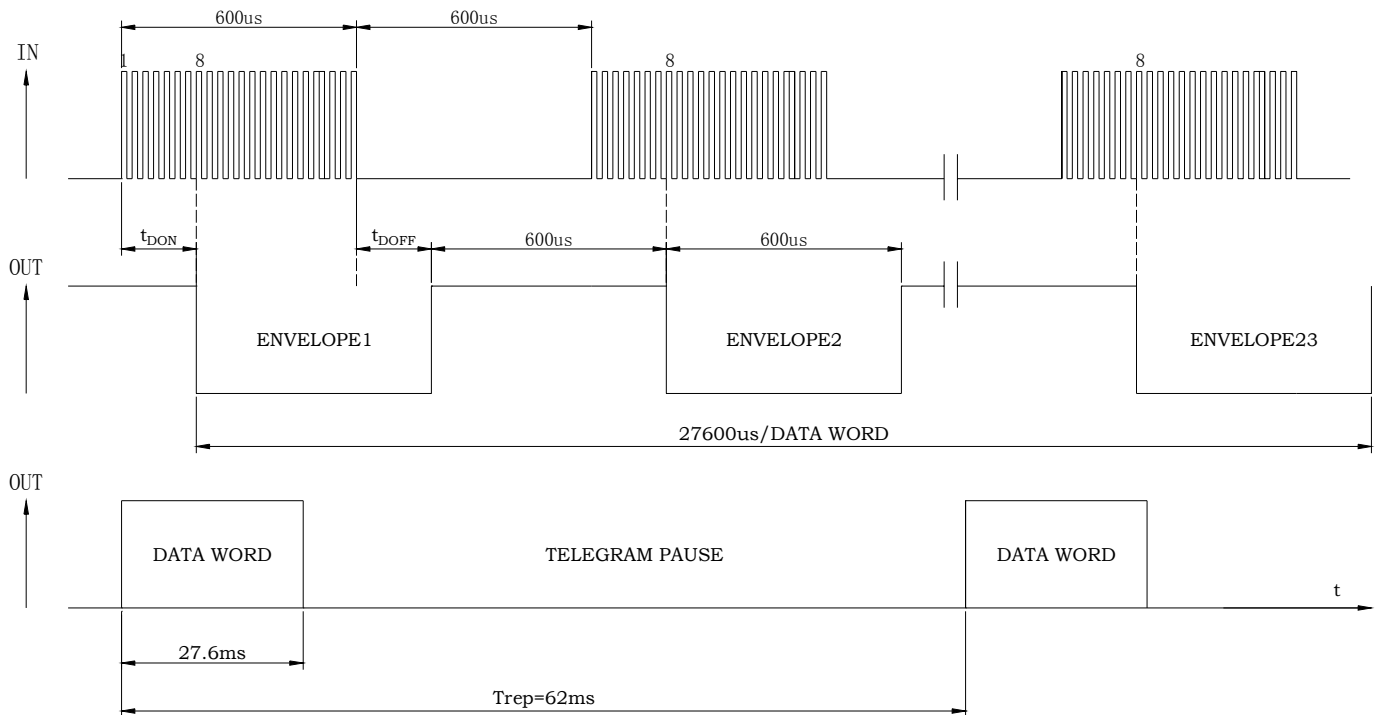



INFRARED REMOTE CONTROL RECEIVER MODULE

PL-IRM0101-3

REV: B / 0

● Absolute Maximum Ratings : (Ta = 25°C)

Symbol	Parameter	Ultra Condition	Unit
Vcc	Supply Voltage	5.5	V
Tstg	Storage Temperature Range	-25to 85	°C
Topr	Operating Temperature Range	-25to 85	°C
Tsol	Soldering Temperature	255(Max 5sec)	°C
Lead Soldering Temperature {1.6mm (0.063inch) From Body} 250±5°C For 3 Seconds.			

● Electro-Optical Characteristics : (Ta = 25°C)

Symbol	Parameter	Condition	Min.	Typ.	Max.	Unit
Vcc	Supply Voltage		4.5	5		V
Icc	Current Consumption	Input signal=0			2.5	mA
λP	Peak Emission Wavelength			940		nm
fo	B.P.F Center Frequency			38		KHz
L	Arrival Distance	L-514EIR1C	0°	35		m
			±45°	8		m
Voh	H Level Output Voltage	30cm Over The Axis	4.5			V
Vol	L Level Output Voltage		0.1	0.5	V	
Twh	H Level Output Pulse Width	Burst Wave=600 μ s	500	600	700	μ s
Twl	L Level Output Pulse Width	Period=1.2ms	500	600	700	μ s
Output Form		Active Low Output				

Note 1. Distance between emitter & detector specifies maximum distance that output waveform satisfies the standard under the conditions below against the standard transmitter.

- ✧ Measuring place-----Indoors without extreme reflection of light.
- ✧ Ambient light source-----Detecting surface illumination shall be 200±50Lux under ordinary fluorescence lamp of no high frequency lighting.
- ✧ Standard transmitter-----Burst wave indicated shall be arranged to 50mVp-p under the measuring circuit.

Note 2. (Electro-optical characteristics) shall be satisfied after leaving 2 hours in the normal temperature.



● Typical Characteristics (Ta=25°C)

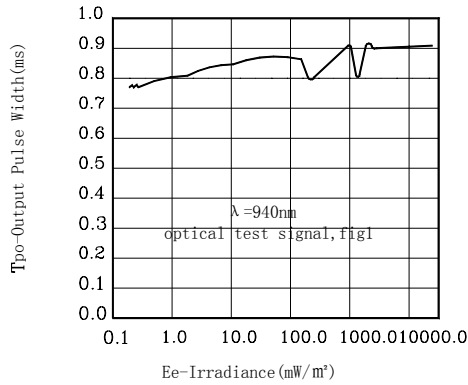

Figure1.Output Pulse Diagram

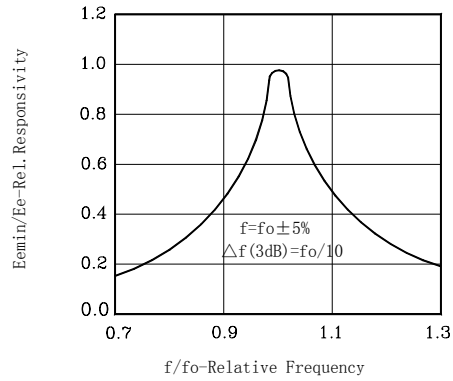

Figure3.Frequency Dependence of Responsivity

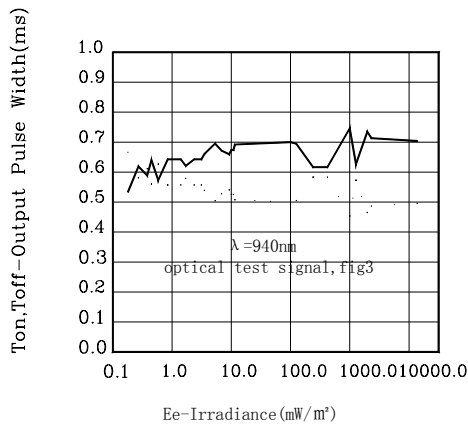

Figure2.Output Pulse Diagram

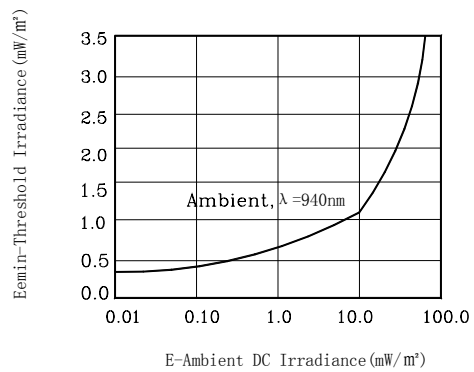

Figure4.Sensitivity In Bright Ambient

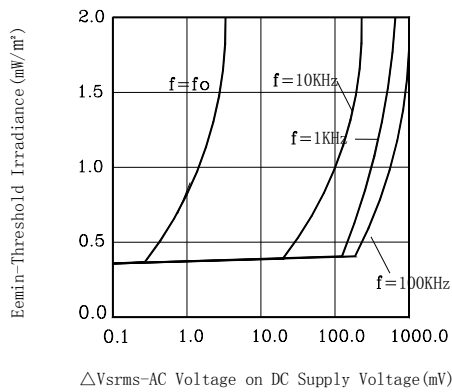

Figure5.Sensitiv vs.Supply Voltage Distances

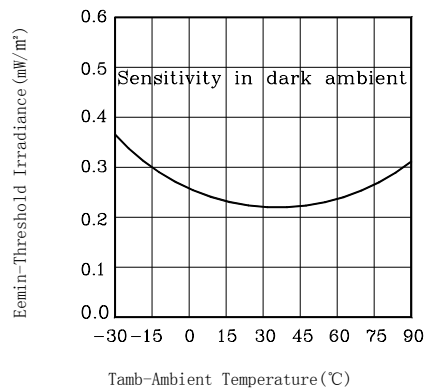

Figure8.Sensitivity vs.Ambient Temperature



● Typical Characteristics (Ta=25°C)

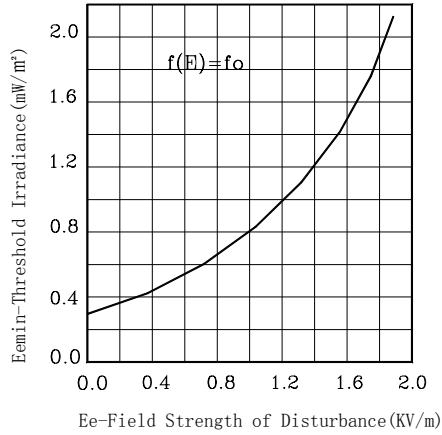

Figure6.Sensitivity vs.Electric Disturbances

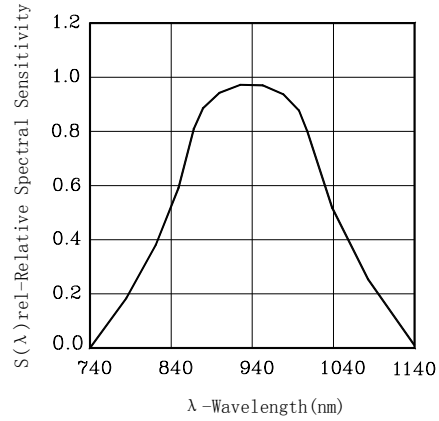

Figure9.Relative Spectral Sensitivity vs.wavelength

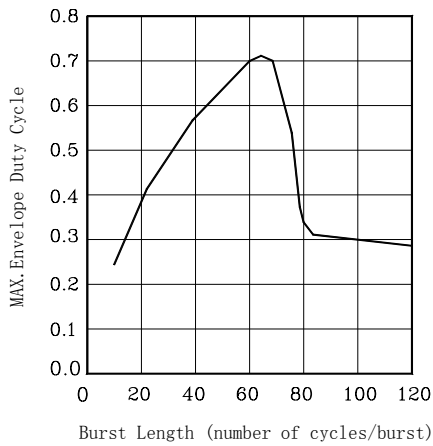

Figure7.Max.Envelope Duty Cycle vs.Burstlength

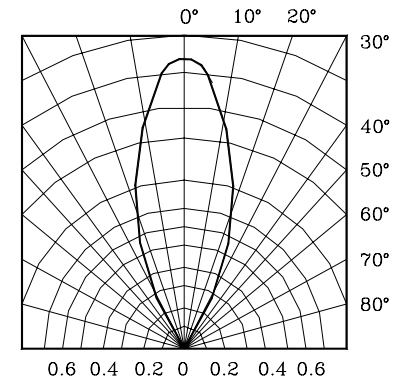

Figure10.Directivity



INFRARED REMOTE CONTROL RECEIVER MODULE

PL-IRM0101-3

REV: B / 0

● Operation Notes(Standard Condition)

IR CODE	IR Receiver PL-IRM0101-3		
	Best Application	Suitable	Not Recommended
Grundig Code		@	
Nec Code		@	
Rc5 Code		@	
Rc6 Code	@		
Rcmm Code	@		
Rcs-80 Code			@
R-2000 Code		@	
Rca Code		@	
Sharp Code		@	
Sony 12bit Code		@	
Sony 15bit Code	@		
Zenith Code		@	
High Data Rate Code			@
Disturbance Suppression	@		

Note: @: Best For Application

● Overview Of The Disturbance Suppression Behavior

Disturbance Lamp	IR Receiver PL-IRM0101-3
From Most Used Fluorescent Lamps (With Switched Supply)	Best Suppression
From Most Used Fluorescent Lamps (With Direct Line Supply)	Best Suppression
From Most Used Fluorescent Lamps (With Strong Ballast)	Possibility Of Disturbance Pulses



- Static-Electricity Resistant Packaging

- Cautions

1. Store and use where there is no force causing transformation or change in quality.
2. Store and use where there is no corrosive gas or sea (salt) breeze.
3. Store and use where there is no extreme humidity.
4. Solder the lead-pin within the condition of ratings. After soldering do not add extra force.
5. Do not wash this device. Wipe the stains of diode side with a soft cloth. You can use the solvent, ethyl alcohol or methyl alcohol or propylene only.
6. To prevent static electricity damage to the Pre-AMP make sure that the human body, the soldering iron is connected to ground before using.
7. Put decoupling device between Vcc and GND for reduce the noise from power supply line.
8. The performance of remote-control system depends on environments condition and ability of peripheral parts. Customer should evaluate the performance as total system in those conditions after system up with components such as commander and this receiver module.
9. This device is not design to endure radioactive rays and heavily charged particles.
10. In case where any trouble or questions arise, all parties agree to make full discussion covering the said problem.



● Reliability Test Item And Condition

Test Items	Test Conditions	Failure Judgment Criteria	Samples (n)
			Defectives(c)
High Temperature Storage	+85°C 240hrs	Performance test requirement and criteria given in page 6 should be satisfied.	N=22 C=0
Low Temperature Storage	-25°C 240hrs		N=22 C=0
Temperature Cycle	-55°C-----+105°C (10min) (10min) 20cycles		N=22 C=0
High Temperature High Humidity	85°C 85%RH 240hrs		N=22 C=0
Soldering Heat	255±5°C 10s		N=22 C=0

● Others:

The appearance and specifications of the product may be modified for improvement without notice.