



ATTENTION  
OBSERVE PRECAUTIONS  
FOR HANDLING  
ELECTROSTATIC  
DISCHARGE  
SENSITIVE  
DEVICES

Part No./型号: **560VG2C**

Ø Features/特征:

- I Single color/单色
- I High bright output/高亮度输出
- I Low power consumption/低功耗
- I High reliability and long life/  
可靠性高、寿命长

Ø Descriptions/描述:

- I Dice material/芯片材质: InGaN
- I Emitting Color/发光颜色:  
Super Bright Green/ 高亮度绿色
- I Device Outline/产品外形:  
φ5mm Round Type/ 5mm 圆形
- I Lens Type 胶体颜色:  
Water Clear/ 无色透明

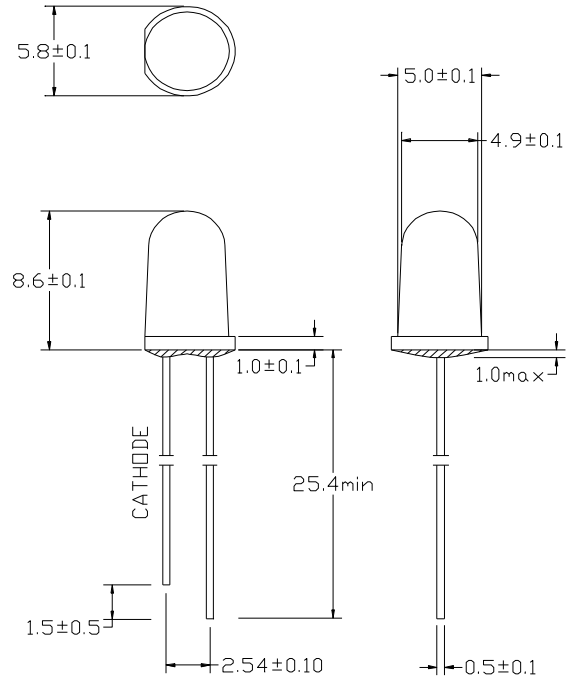

1. All dimensions are millimeters/单位: mm.
2. Tolerance is  $\pm 0.25 \text{ mm}$  unless otherwise noted/  
没有标注的公差均为  $\pm 0.25 \text{ mm}$ .

Ø Directivity/指向特性:

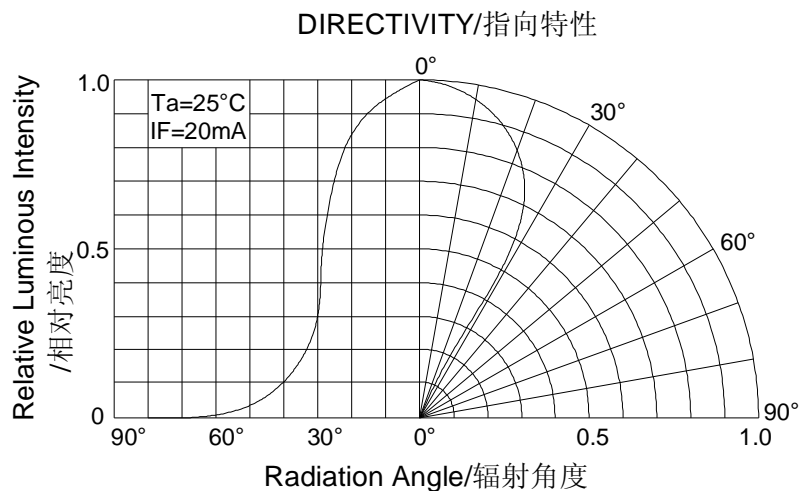

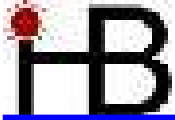

**Ø Absolute maximum ratings/极限参数 (Ta = 25°C)**

Parameter 参数	Symbol 符号	Test Condition 测试条件	Values 数值		Unit 单位
			Min.	Max.	
Reverse Voltage 反向电压	V <sub>R</sub>	I <sub>R</sub> = 30 μ A	5	--	V
Forward Current 正向工作电流	I <sub>F</sub>	----	----	25	mA
Power Dissipation 损耗功率	P <sub>d</sub>	----	----	90	mW
Pulse Current 正向峰值电流	I <sub>peak</sub>	Duty=0.1mS, 1kHz	----	100	mA
Operating Temperature 工作温度范围	T <sub>opr</sub>	----	-40	+85	°C
Storage Temperature 储存温度范围	T <sub>str</sub>	----	-40	+100	°C
Electrostatic Discharge Rank 抗静电等级	ESD	MIL-STD883E (HBM)	Class1		---

**Ø Electrical and optical characteristics/光电参数 (Ta = 25°C)**

Parameter 参数	Symbol 符号	Test Condition 测试条件	Values 数值			Unit 单位
			Min.	Typ.	Max.	
Forward Voltage 正向电压	V <sub>F</sub>	I <sub>F</sub> =20mA	----	3.5	4.0	V
Reverse Current 反向电流	I <sub>R</sub>	V <sub>R</sub> =5V	----	----	30	μ A
Dominate Wavelength 主波长	λ <sub>d</sub>	I <sub>F</sub> =20mA	----	525	----	nm
Peak Wavelength 峰值波长	λ <sub>p</sub>	I <sub>F</sub> =20mA	----	520	----	nm
Spectral Line half-width 半波长宽度	Δ λ	I <sub>F</sub> =20mA	----	35	----	nm
Luminous Intensity 发光强度	I <sub>v</sub>	I <sub>F</sub> =20mA	----	1500	----	mcd
Viewing Angle 指向角度	2 θ 1/2	I <sub>F</sub> =20mA	----	53	----	deg.

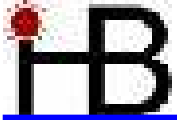

**Ø Typical electrical/optical characteristic curves/光电特性曲线:**

Fig.1 正向电流 Vs. 正向电压

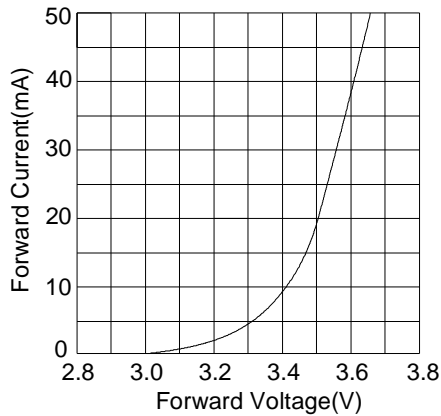

Fig.2 相对亮度 Vs. 正向电流

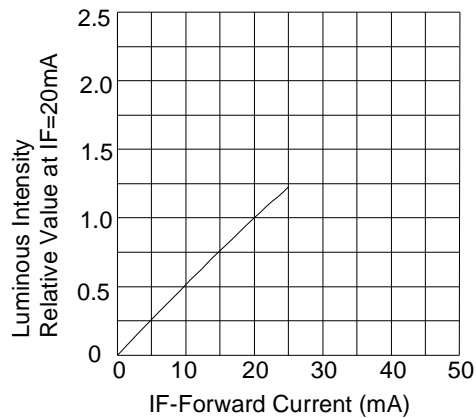

Fig.3 正向电流 Vs. 环境温度

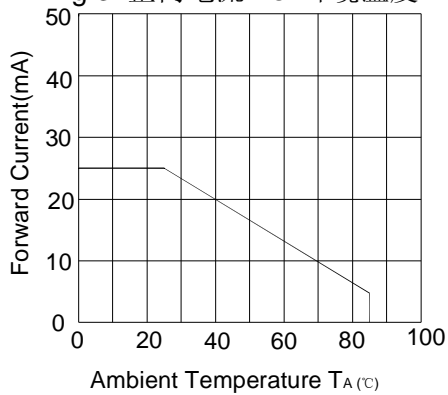

Fig.4 相对亮度 Vs. 环境温度

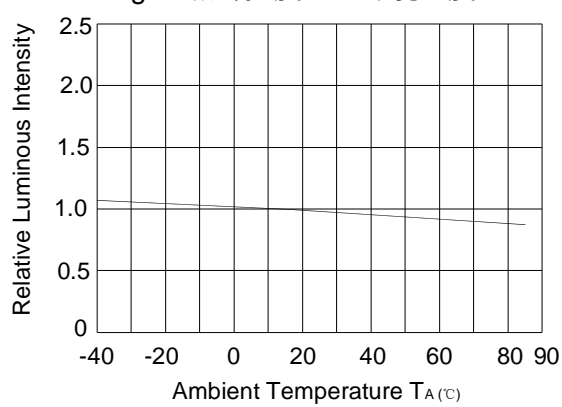

Fig.5 相对亮度 Vs. 波长

