

Part No./型号: **530PWO4C**



ATTENTION

OBSERVE PRECAUTIONS FOR HANDLING ELECTROSTATIC DISCHARGE SENSITIVE DEVICES

Features/特征:

- Single color/特征
- High bright output/高亮度输出
- Low power consumption/低功耗
- High reliability and long life/可靠性高、寿命长
- Low brightness declines/低光衰

Descriptions/描述:

- Dice material/芯片材质: GaInN
- Emitting Color/发光颜色:
Super Bright White/高亮度白色
- Device Outline/产品外形:
φ5mm Round Type/5mm 圆形
- Lens Type/胶体颜色: Water Clear/无色透明

Directivity/指向特性:

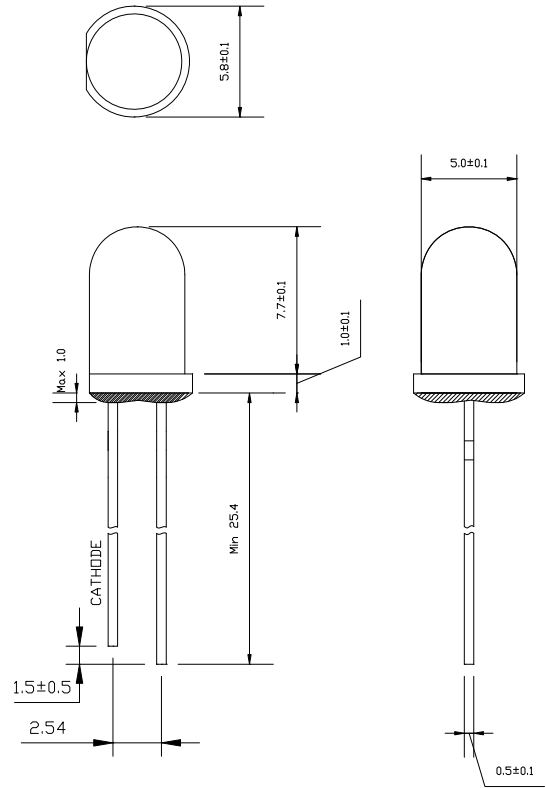

NOTE/注意:

- All dimensions are millimeters/单位: mm
- Tolerance is ± 0.25 mm unless otherwise noted/没有标注的公差为 ± 0.25 mm

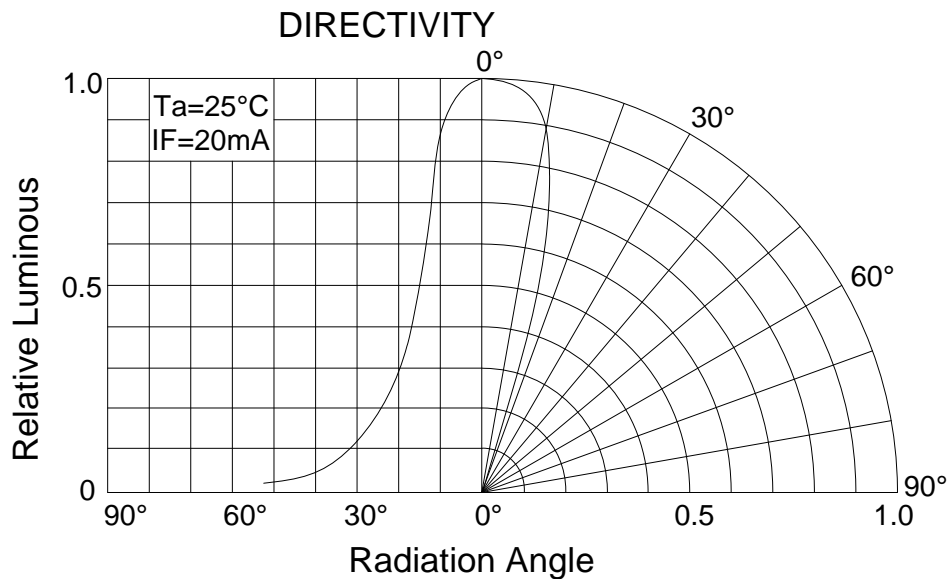

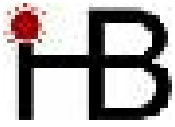

Part No./型号: **530PWO4C**

Absolute maximum ratings/极限参数 (Ta = 25°C)

| Parameter 参数 | Symbol 符号 | Test Condition 测试条件 | Value 数值 | | Unit 单位 |
|---------------------------------|-------------------|-------------------------|----------|------|------------|
| | | | Min. | Max. | |
| Reverse Voltage 反向电压 | V _R | I _R = 30 μ A | 5 | -- | V |
| Forward Current 正向工作电流 | I _F | ---- | ---- | 25 | mA |
| Power Dissipation 损耗功率 | P _d | ---- | ---- | 108 | mW |
| Pulse Current 正向峰值电流 | I _{peak} | Duty=0.1mS, 1kHz | ---- | 100 | mA |
| Operating Temperature 工作温度范围 | T _{opr} | ---- | -40 | +85 | °C |
| Storage Temperature 储存温度范围 | T _{str} | ---- | -40 | +100 | °C |

Electrical and optical characteristics /光电参数 (Ta = 25°C)

| Parameter 参数 | Symbol 符号 | Test Condition 测试条件 | Value 数值 | | | Unit 单位 |
|----------------------------|----------------|------------------------|----------|------|------|------------|
| | | | Min. | Typ. | Max. | |
| Forward Voltage 正向电压 | V _F | I _F = 20mA | ---- | 3.2 | 3.6 | V |
| Reverse Current 反向电流 | I _R | V _R = 5V | ---- | ---- | 30 | μ A |
| Luminous Intensity 发光强度 | I _v | I _F = 20mA | ---- | 8000 | ---- | mcd |
| Viewing Angle 指向角度 | 2 θ 1/2 | I _F = 20mA | 24 | | 30 | Deg. |

Luminous Intensity Bins Chart/发光强度分档 (Ta = 25°C)

| Bin | V | W | X | Y | Z1 |
|-----|------|------|------|------|-------|
| Min | 2000 | 3000 | 4000 | 6000 | 8000 |
| Max | 3000 | 4000 | 6000 | 8000 | 10000 |

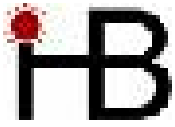

Part No./型号: **530PWO4C**

Color Temperature Bins Char/色温分档 (Ta = 25°C)

| | | | | | |
|-----|-----------|-----------|-----------|-----------|-----------|
| Bin | WP0 | WP1 | WP2 | WP3 | WP4 |
| CCT | <2500 | 2500~2800 | 2800~3000 | 3000~3300 | 3300~3600 |
| Bin | WP5 | WP6 | WP7 | WP8 | WP9 |
| CCT | 3600~4000 | 4000~4500 | 4500~5000 | 5000~6000 | >6000 |

Typical electrical/optical characteristic curves/光电特性曲线:

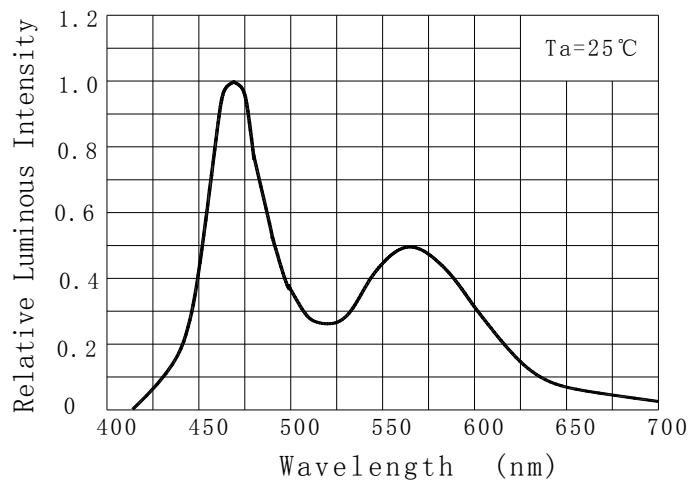
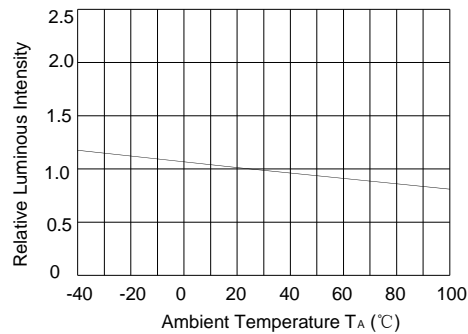
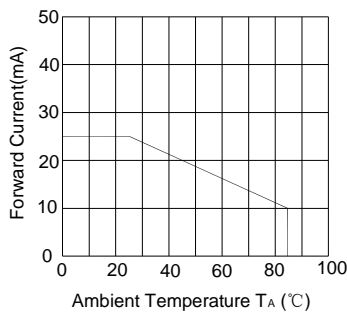
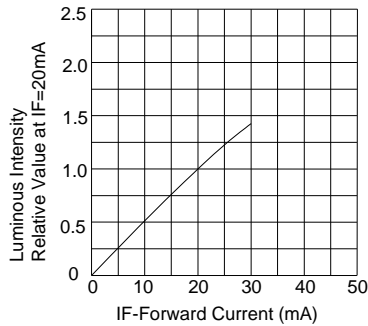
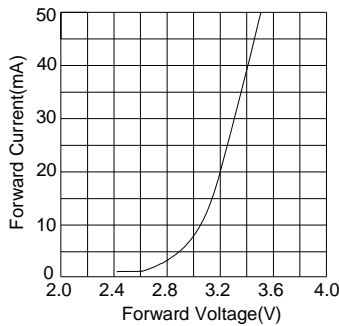

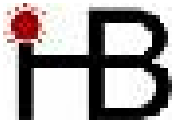

Part No./型号: **530PWO4C**

Life Test curves /寿命测试曲线

