

Part No./型号: 412PWO4C

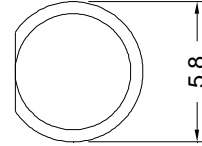

**ATTENTION**  
OBSERVE PRECAUTIONS  
FOR HANDLING  
ELECTROSTATIC  
DISCHARGE  
SENSITIVE  
DEVICES



**Features/特征:**

- I Single color/特征
- I High bright output/高亮度输出
- I Low power consumption/低功耗
- I High reliability and long life/可靠性高、寿命长
- I Low brightness declines/低光衰

**Descriptions/描述:**

- I Dice material/芯片材质: GaInN
- I Emitting Color/发光颜色:  
Super Bright White/高亮度白色
- I Device Outline/产品外形:  
φ5mm Round Type/5mm 圆形
- I Lens Type/胶体颜色: Water Clear/无色透明

**Directivity/指向特性:**

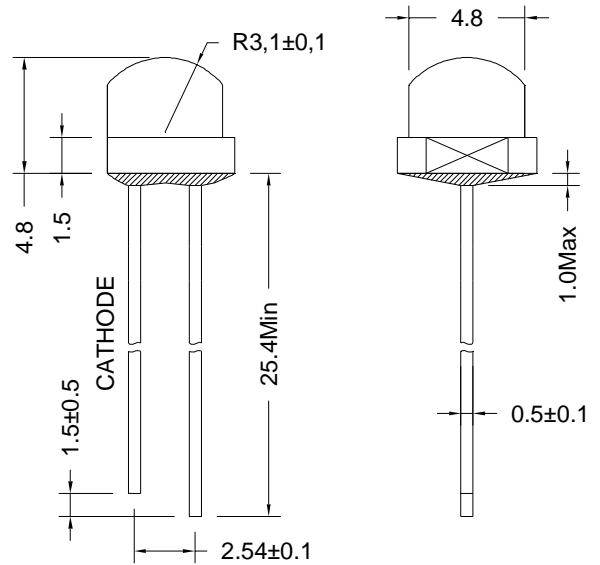

**NOTE/注意:**

- I All dimensions are millimeters/所有尺寸单位: mm.
- I Tolerance is +/-0.20mm unless otherwise noted/未标注的公差均为±0.20mm

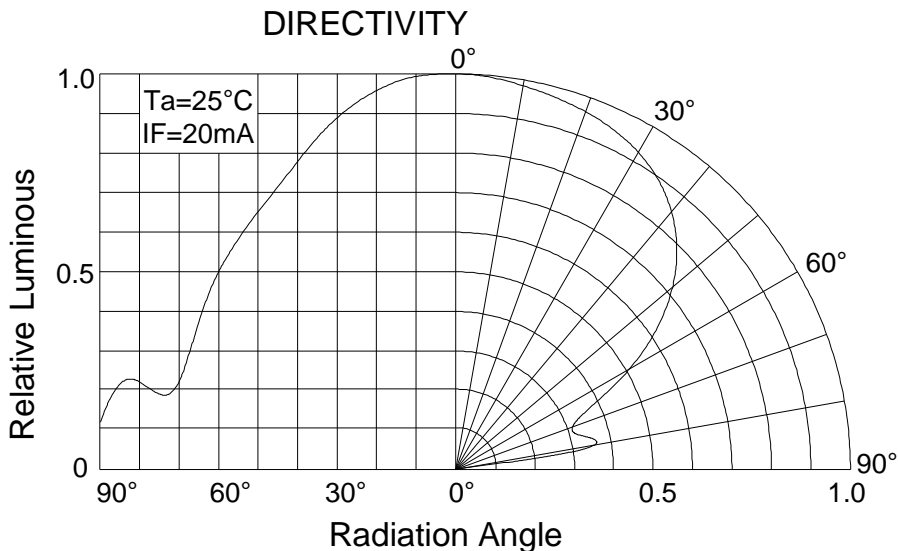

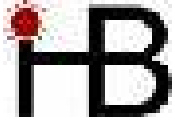

Part No./型号: **412PWO4C**

**Absolute maximum ratings/极限参数 (Ta = 25°C)**

Parameter 参数	Symbol 符号	Test Condition 测试条件	Value 数值		Unit 单位
			Min.	Max.	
Reverse Voltage 反向电压	VR	IR = 30 μ A	5	--	V
Forward Current 正向工作电流	IF	----	----	25	mA
Power Dissipation 损耗功率	Pd	----	----	90	mW
Pulse Current 正向峰值电流	Ipeak	Duty=0.1mS, 1kHz	----	100	mA
Operating Temperature 工作温度范围	Topr	----	-40	+85	°C
Storage Temperature 储存温度范围	Tstr	----	-40	+100	°C

**Electrical and optical characteristics /光电参数 (Ta = 25°C)**

Parameter 参数	Symbol 符号	Test Condition 测试条件	Value 数值			Unit 单位
			Min.	Typ.	Max.	
Forward Voltage 正向电压	VF	IF = 20mA	----	3.2	3.6	V
Reverse Current 反向电流	IR	VR = 5V	----	----	30	μ A
Luminous Intensity 发光强度	IV	IF = 20mA	----	800	----	mcd
Viewing Angle 指向角度	2 θ 1/2	IF = 20mA	----	120	----	Deg.

**Luminous Intensity Bins Chart/发光强度分档 (Ta = 25°C)**

Bin	Q	R	S	T
Min	400	600	800	1000
Max	600	800	1000	1500

**Color Temperature Bins Char/色温分档 (Ta = 25°C)**

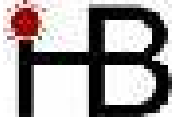

**Part No./型号: 412PWO4C**

Bin	WP0	WP1	WP2	WP3	WP4
CCT	<2500	2500~2800	2800~3000	3000~3300	3300~3600
Bin	WP5	WP6	WP7	WP8	WP9
CCT	3600~4000	4000~4500	4500~5000	5000~6000	>6000

**Typical electrical/optical characteristic curves/光电特性曲线:**

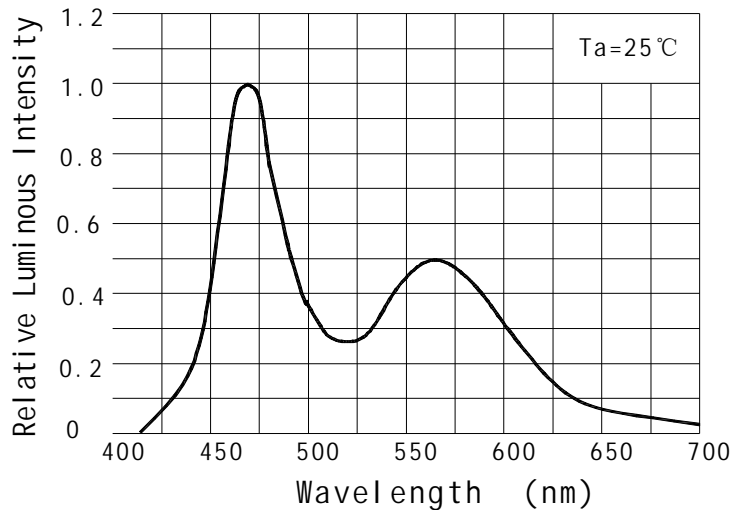
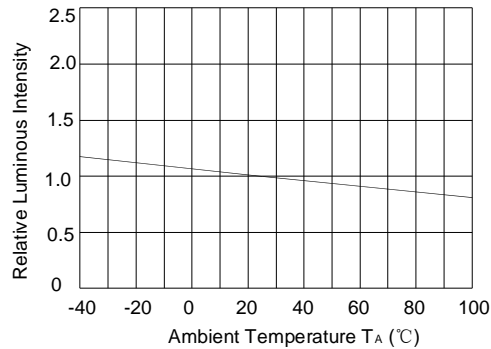
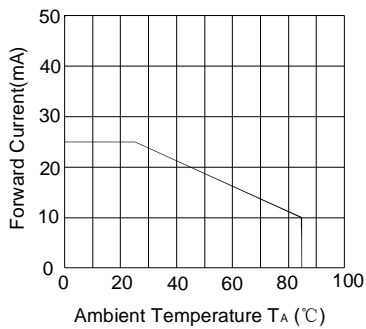
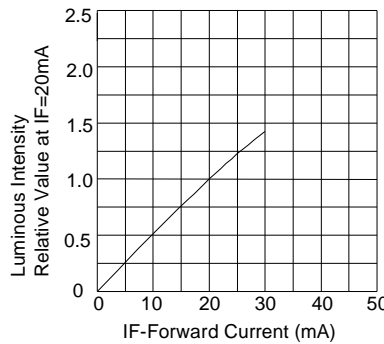
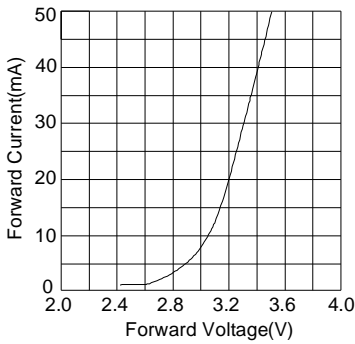

**Life Test curves /寿命测试曲线**

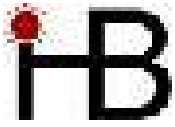

Part No./型号: 412PWO4C

